

# DÔME GÉODÉSIQUE 3V 5/8

ø 6.6 m  
 surface au sol 34.19 m<sup>2</sup>  
 Circ. 20.72  
 Hauteur 3.86 m



## ENTRAXES

- |                               |                                     |
|-------------------------------|-------------------------------------|
| <b>A</b> = 0.1747 ø = 115,3   | <b>AUVENT</b>                       |
| <b>B</b> = 0.2018 ø = 133,1   | <b>P1</b> = 0.349 ø = 230,3 cm      |
| <b>C</b> = 0.2062 ø = 136,1   | <b>P2</b> = 0.309 ø = 204 cm        |
| <b>C2</b> = 0.19935 ø = 131,6 | + prévoir hauteur plancher          |
|                               | <b>P3</b> = 0.216 ø = 143 cm        |
|                               | <b>P4</b> = 0.31 ø = 200 cm environ |
|                               | <b>P5</b> = 0.336 ø = 221.9 cm      |
|                               | <b>P6</b> = 0.14 ø = 92.4 cm        |
|                               | <b>P7</b> = 0.258 ø = 170.1 cm      |

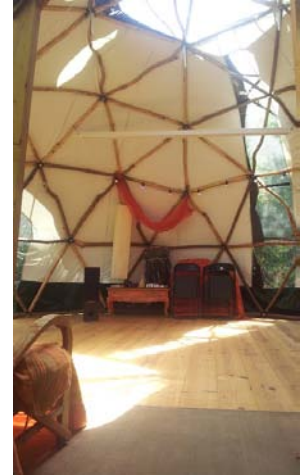
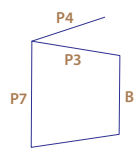
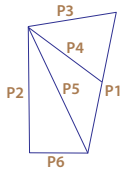
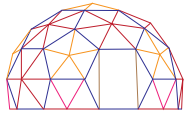
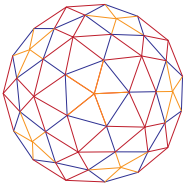

Dôme de 7m  
Yoann Omaé

1M

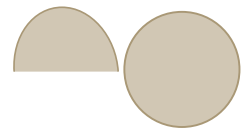
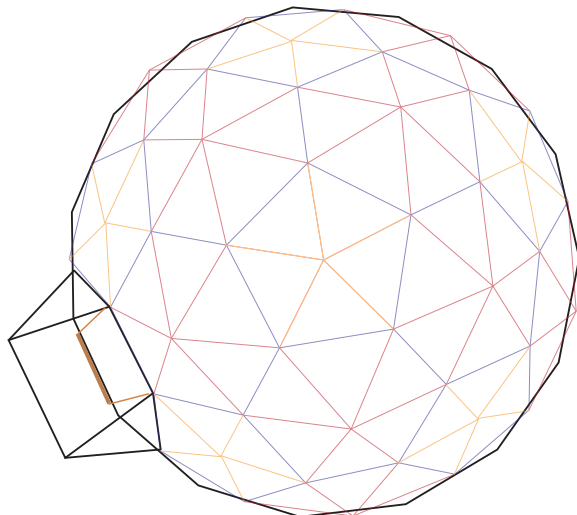
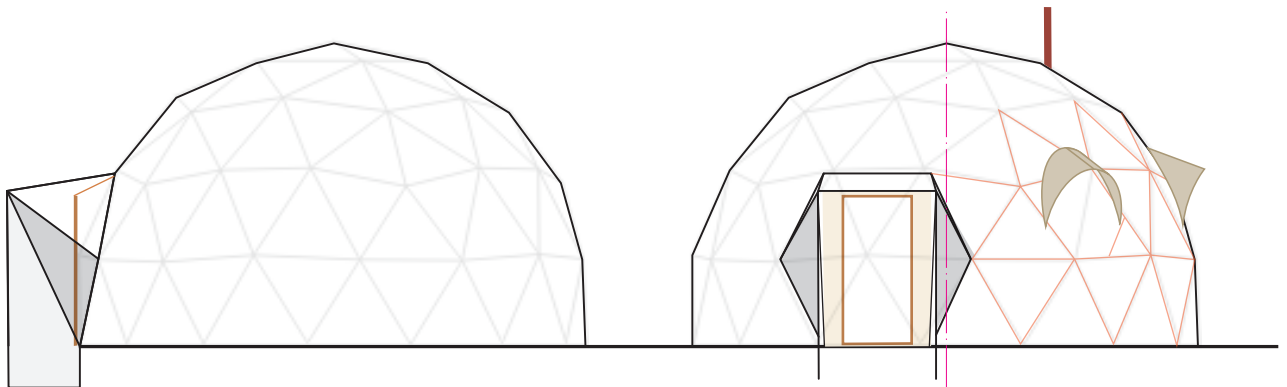

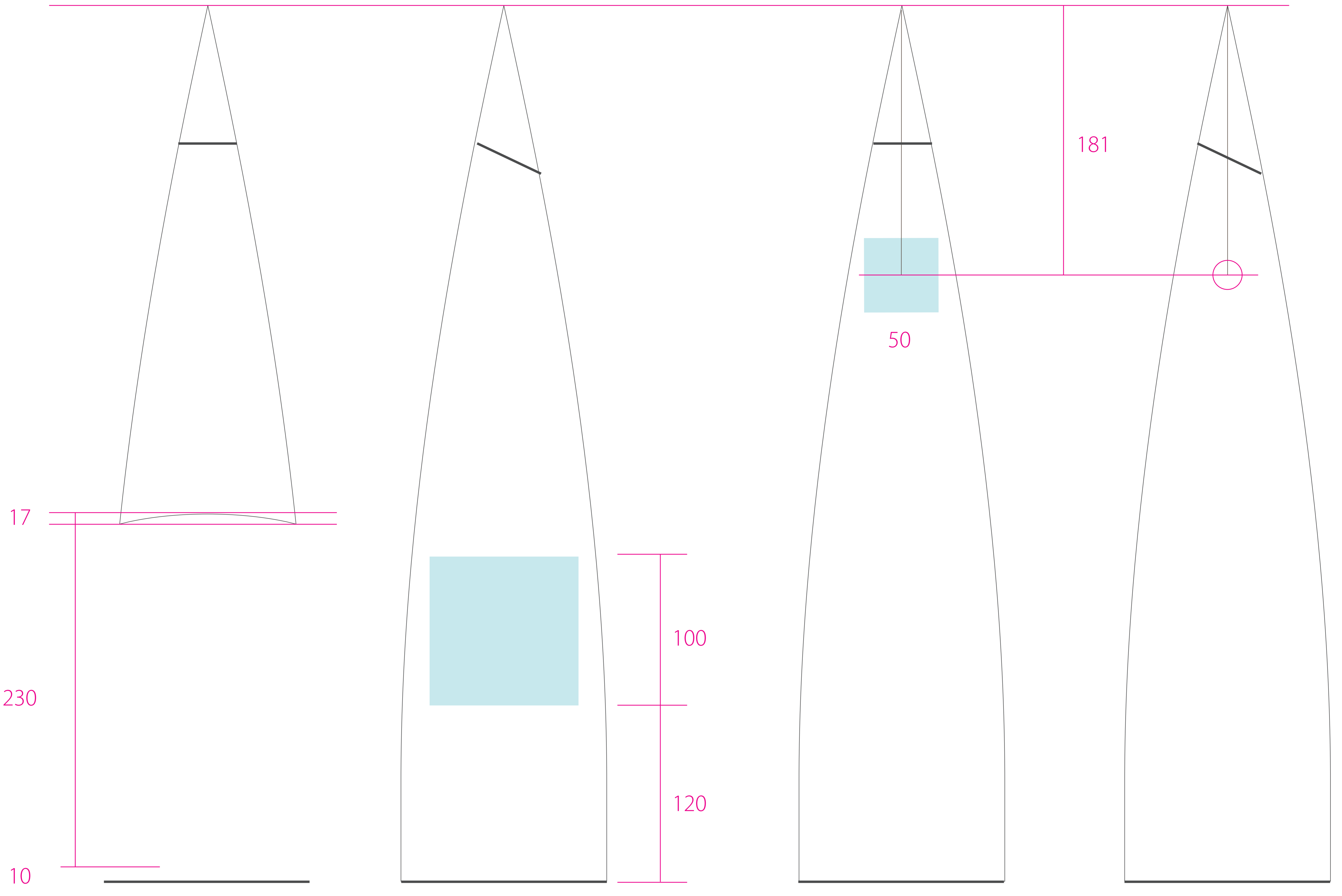

PORTE

7

6

POELE

JOINTURE BARRES

10cm

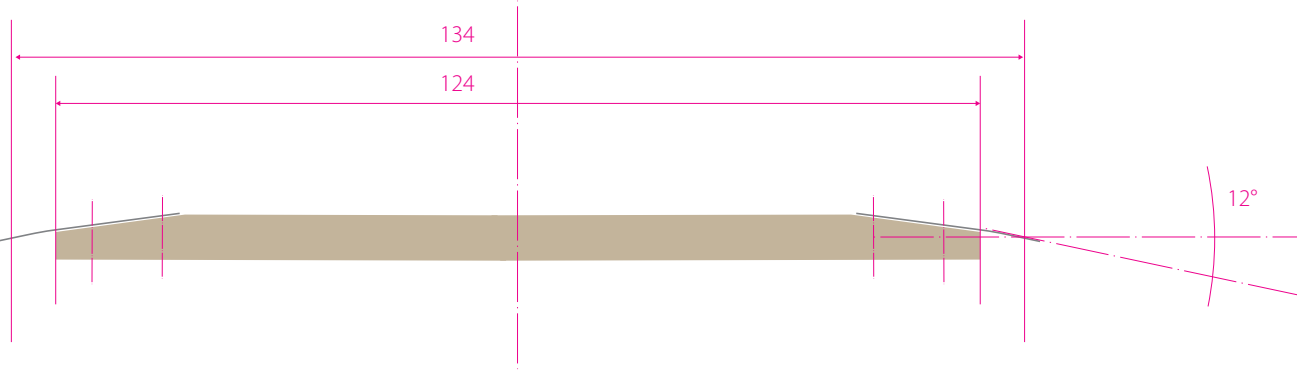
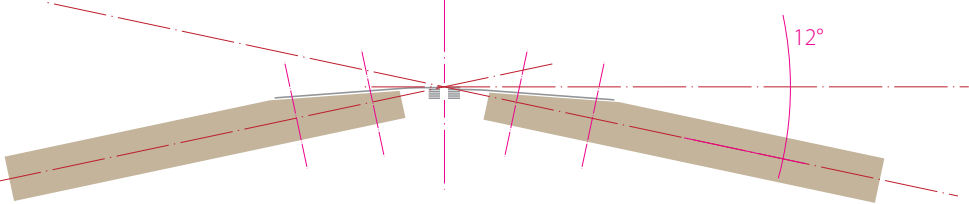
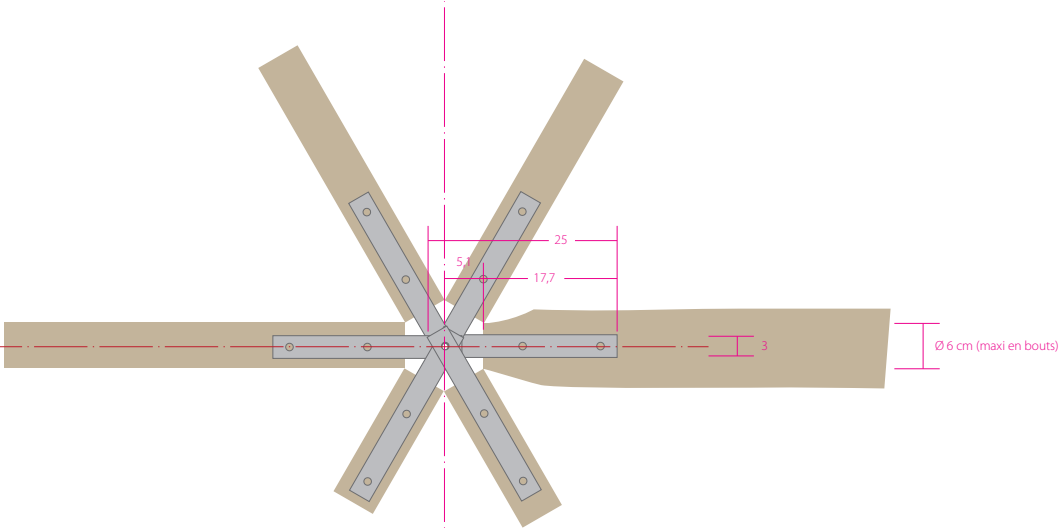

AMÉNAGEMENT  
OUVERTURES

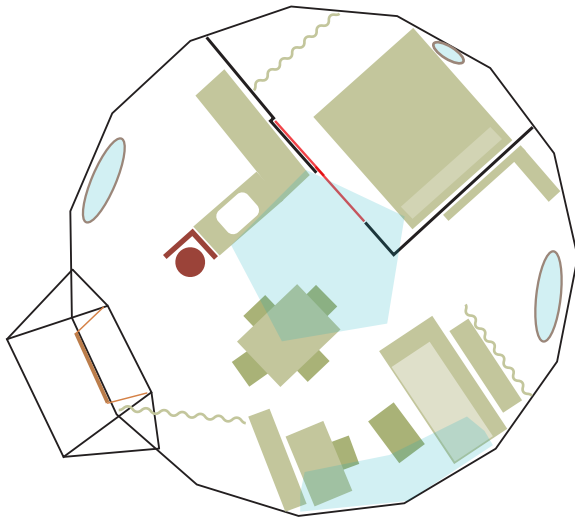
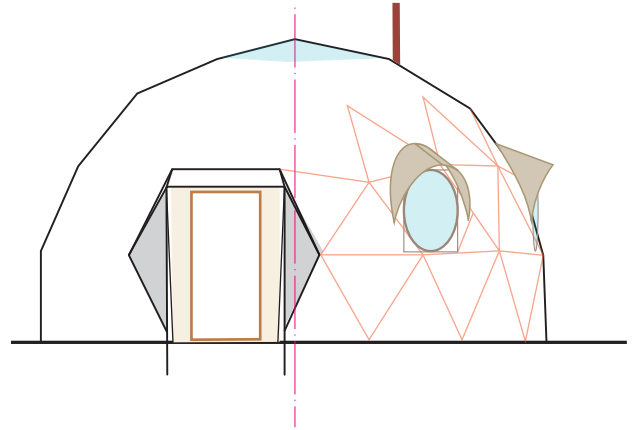
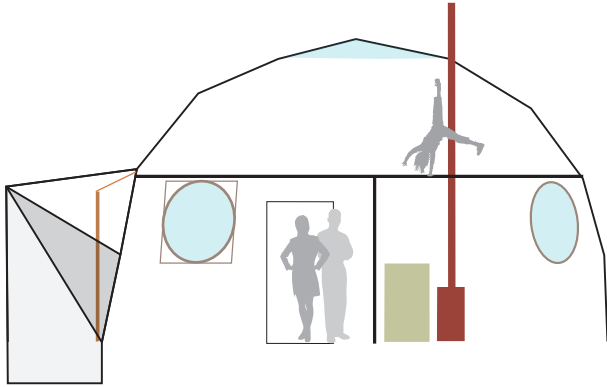

PASSAGE TUYAU

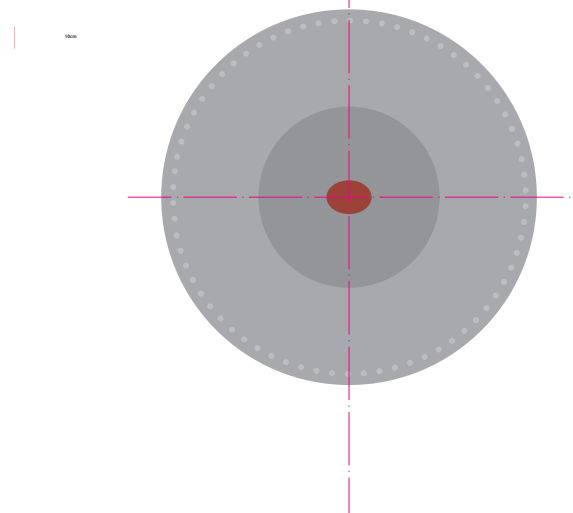
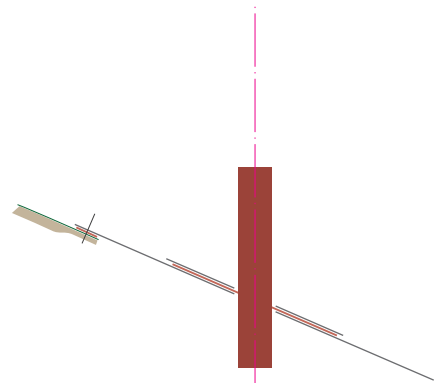

MEZZANINE

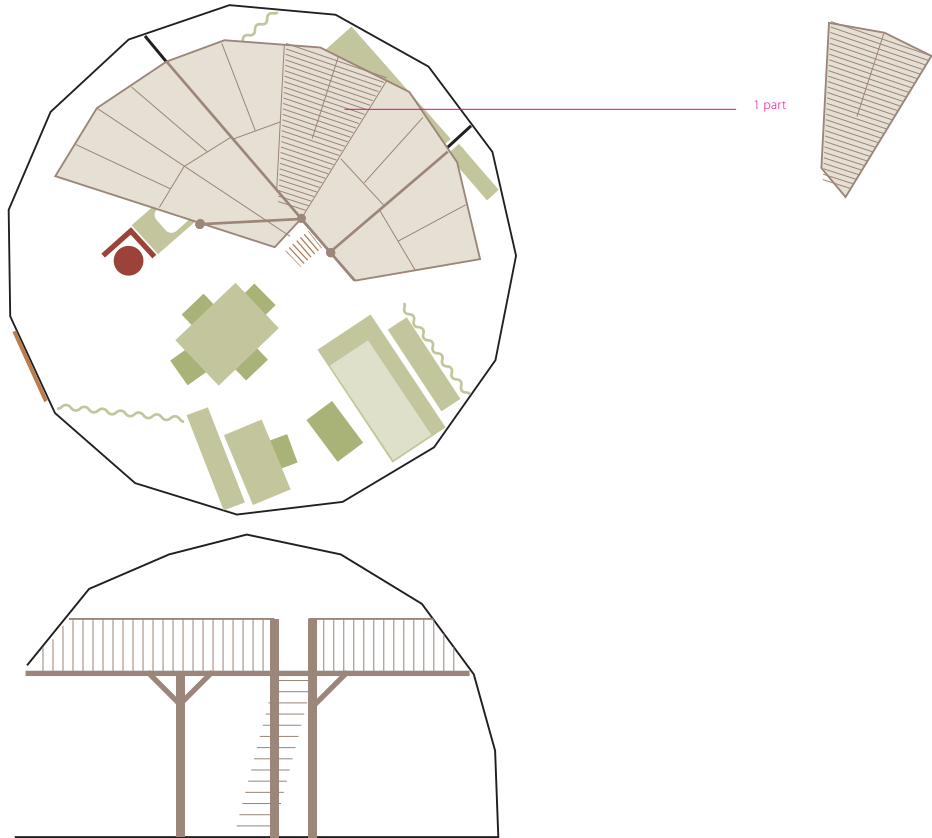

PLANCHER

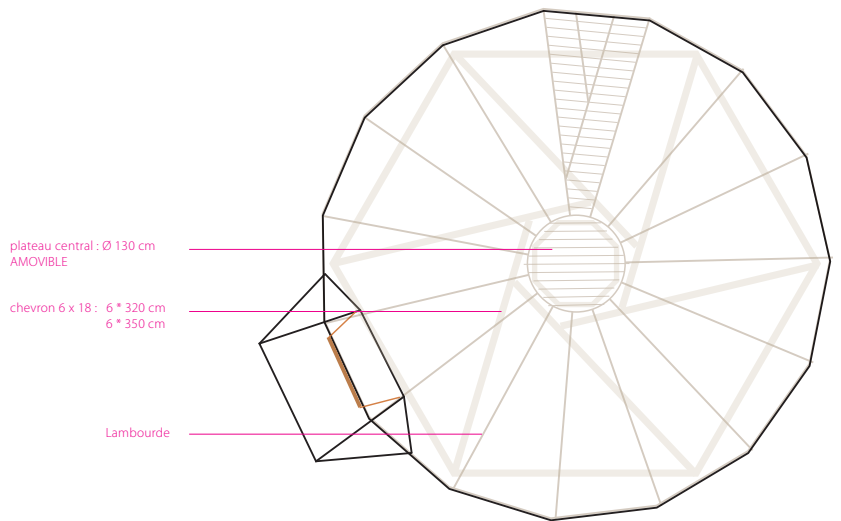
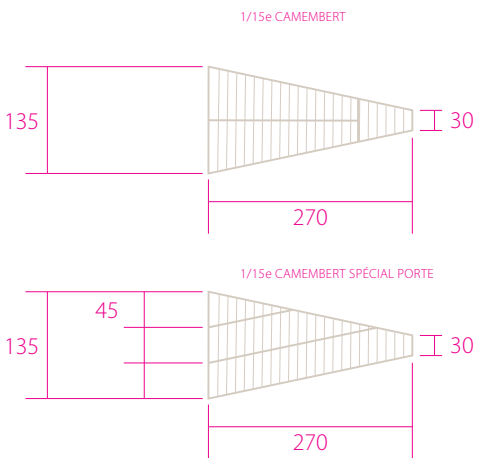
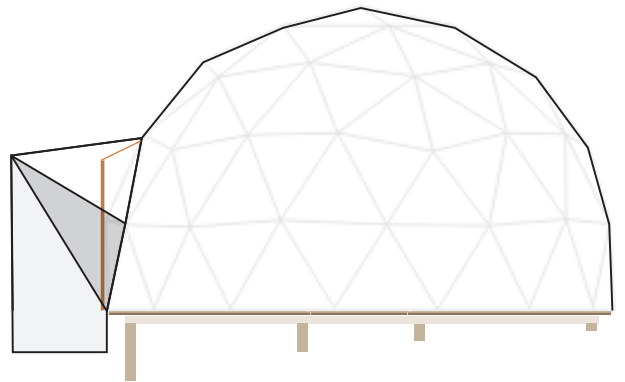

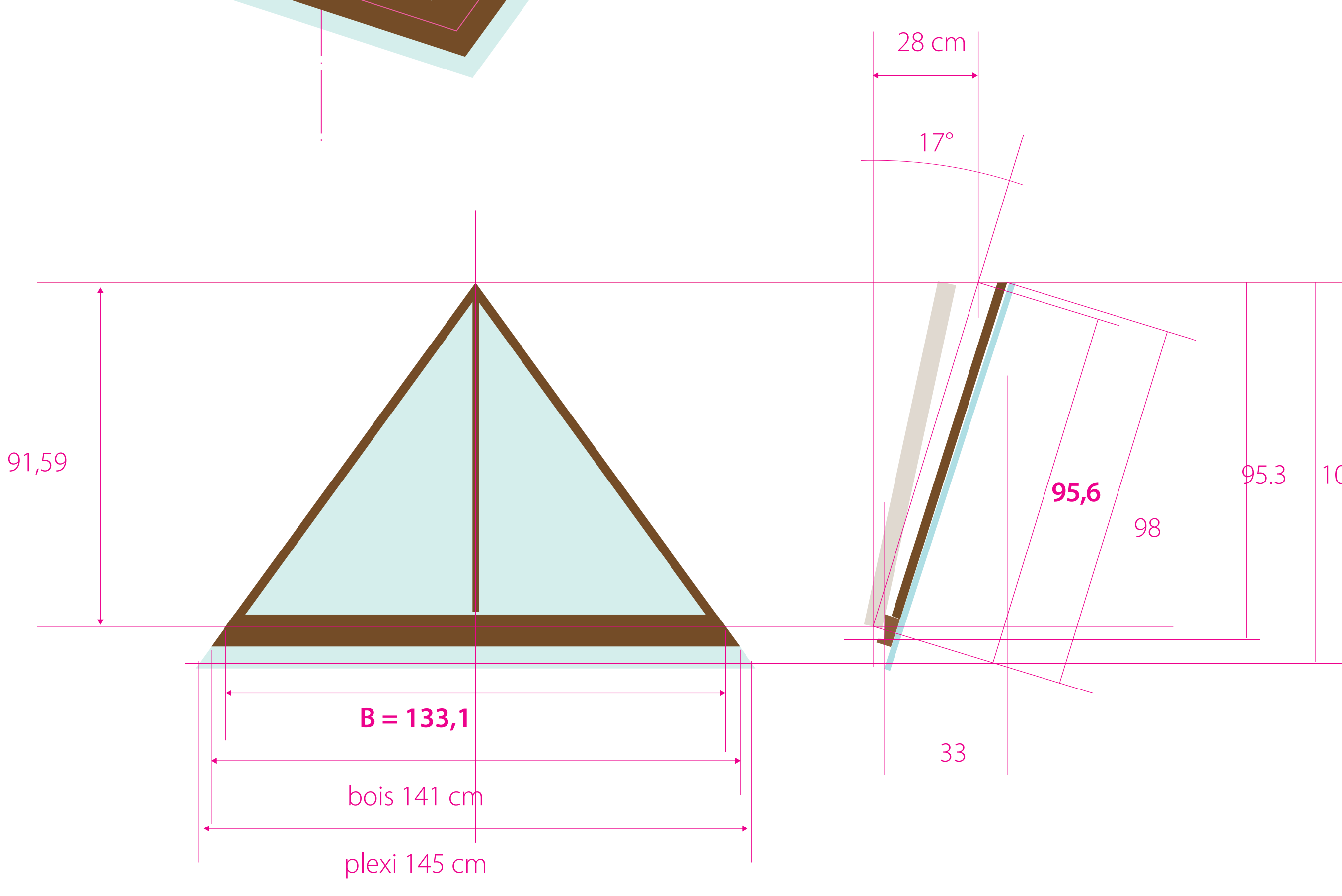
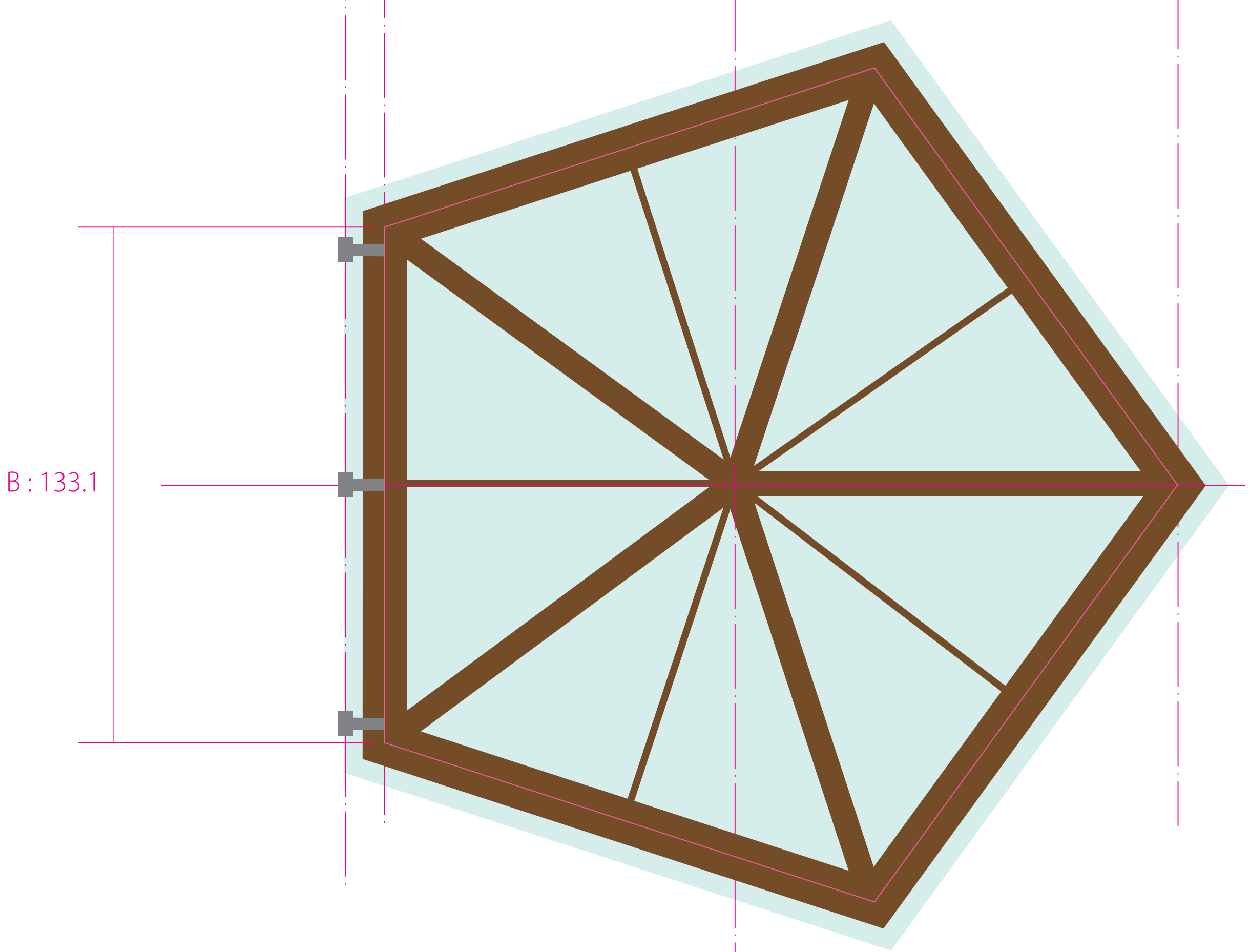
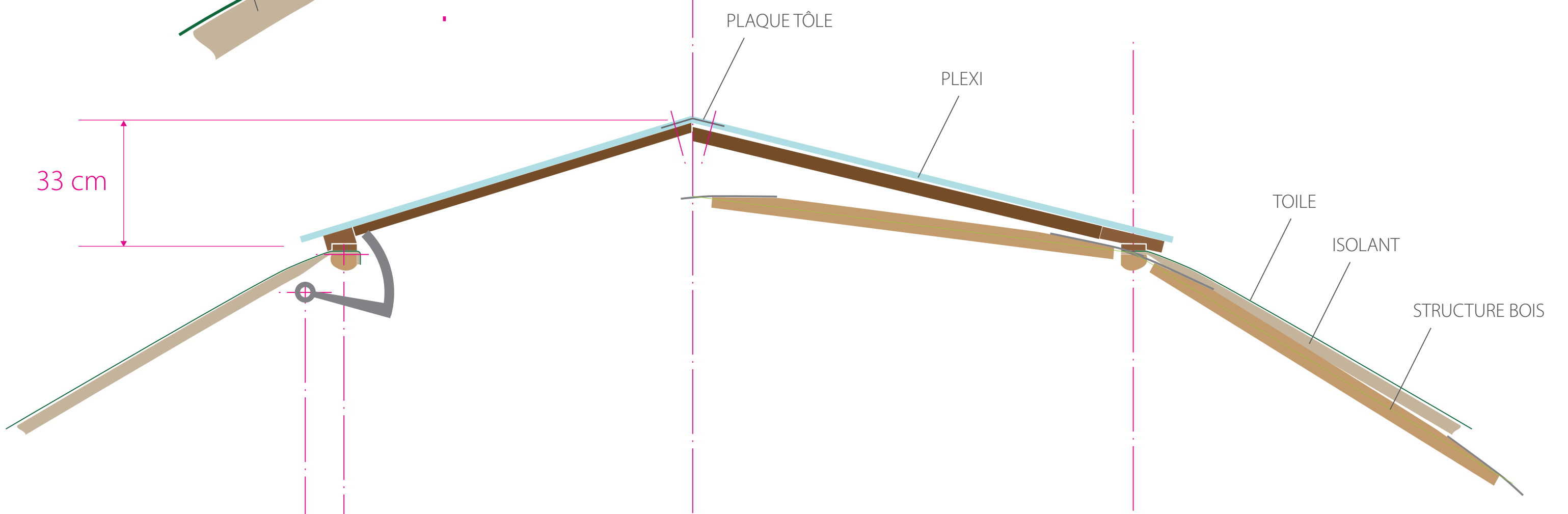
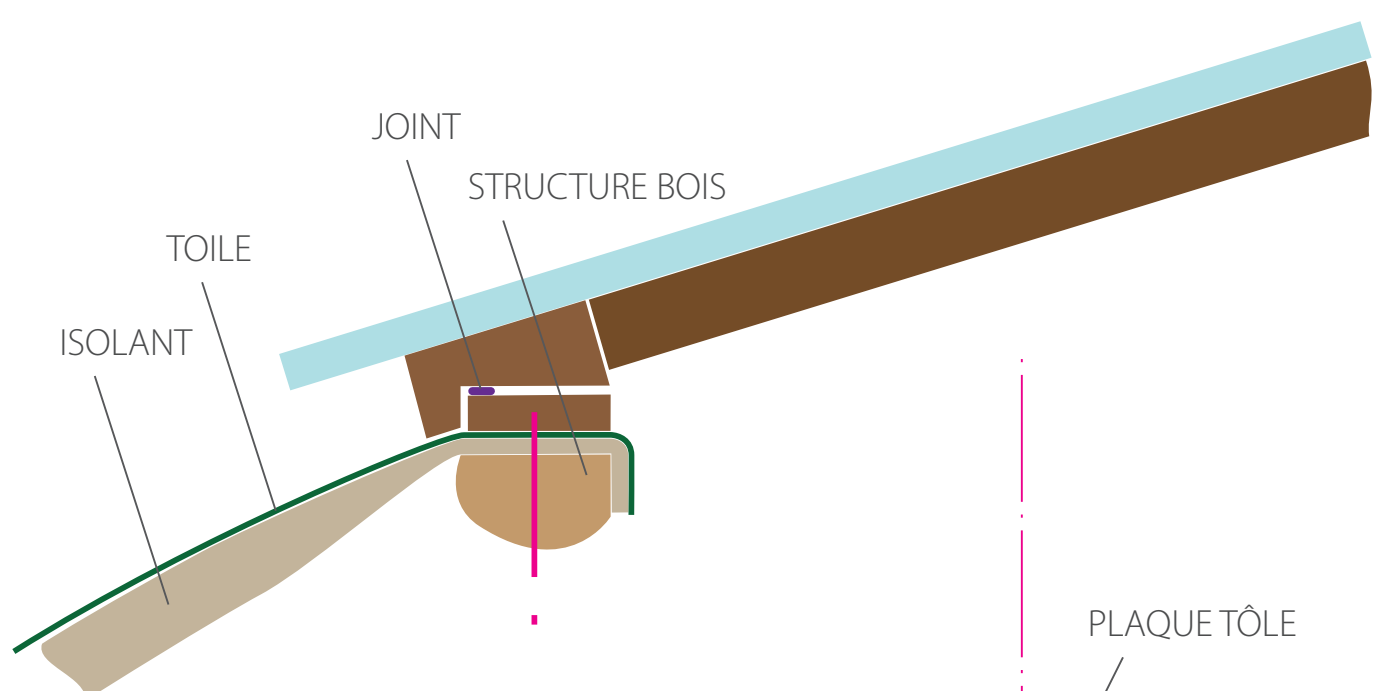

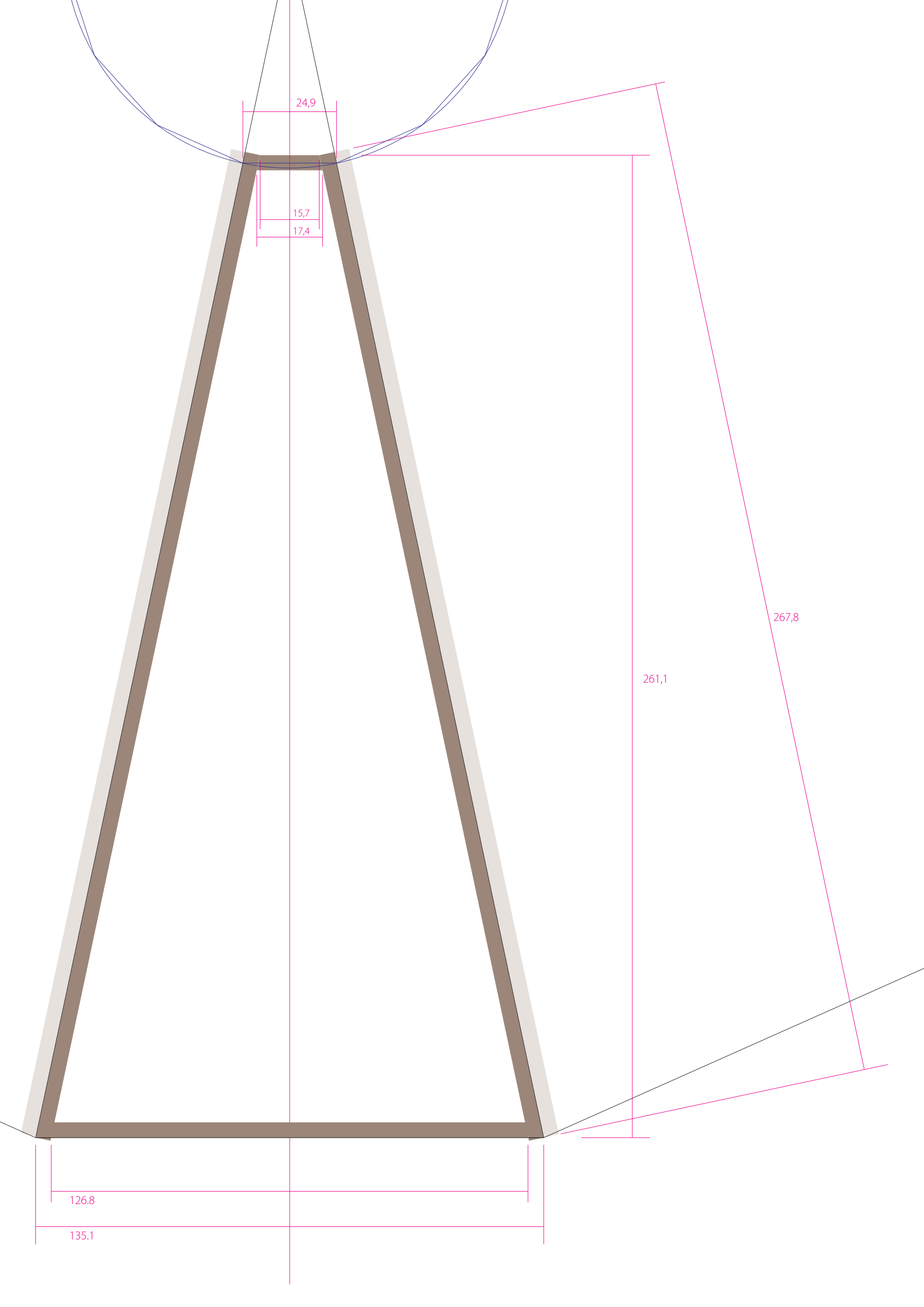

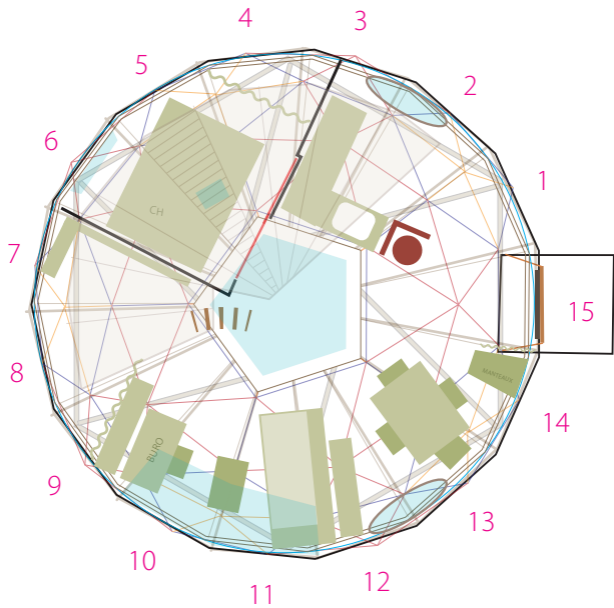

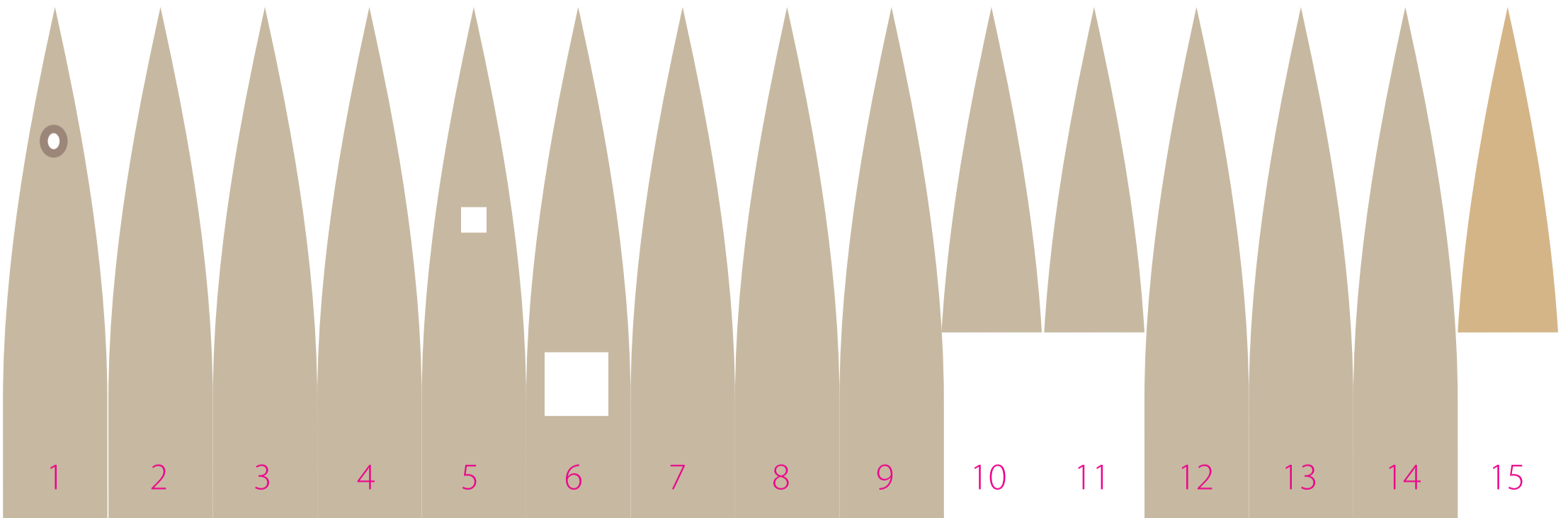
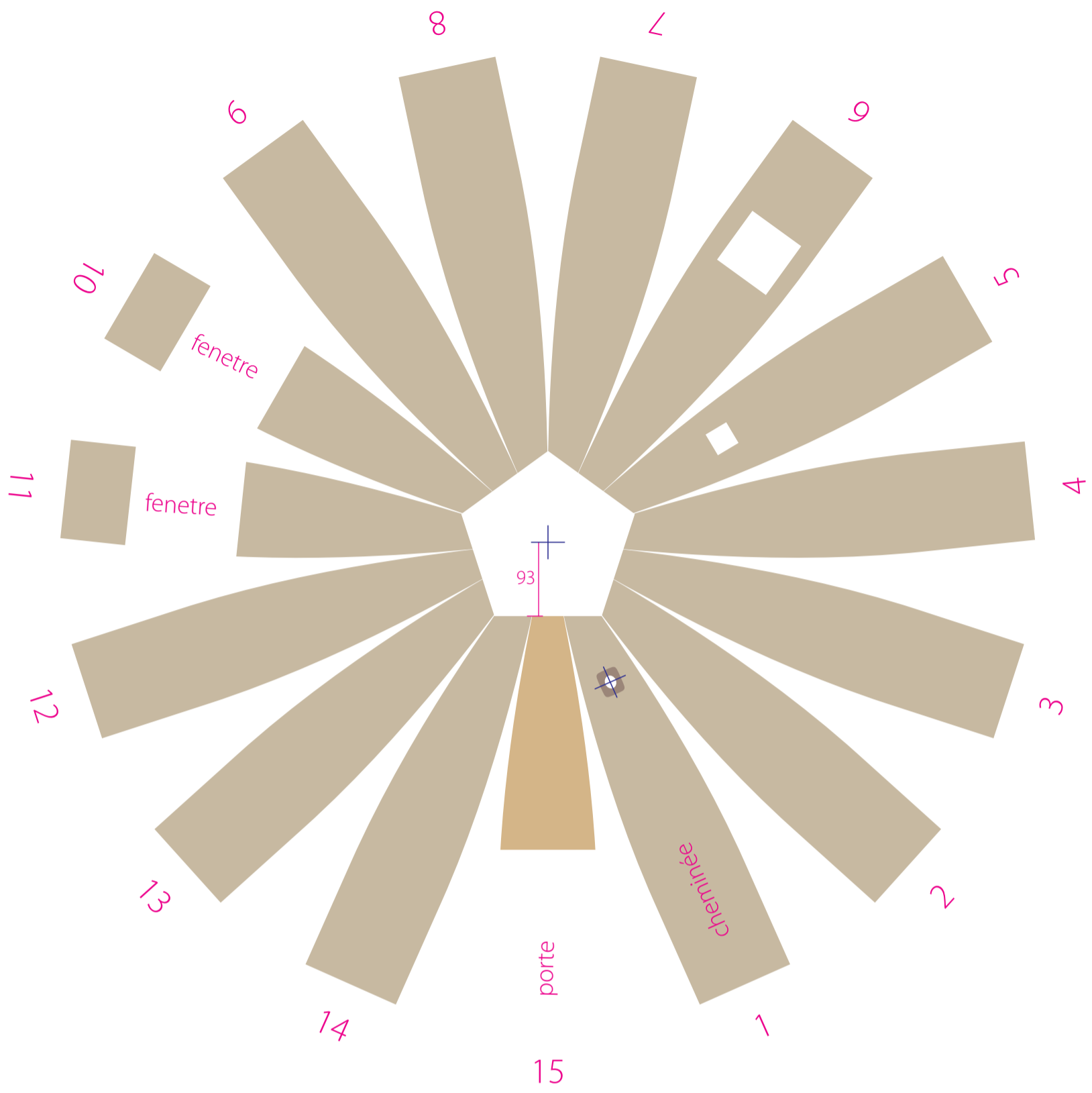

cheminée

fenetre

fenetre

